



85/100/130

Smart Screen



**Transparent screen med optisk komfort.
Undertrykker det intense sollys uden det
opleves for mørkt.**

- Special legering sikrer god holdbarhed.
- Flere motormuligheder – ex batterimotor med solfanger eller online kommunikation.
- Forstærket screenstof fremstillet af optimale materialer giver stor modstandsdygtighed.
- Zipp-lås giver stor holdbarhed og beskytter mod insekter og hårde vinde.
- Størrelse op til 700 x 600 cm.

**5 ÅRS
GARANTI**

07.01.2025

kirsch[™]

Smart 85

Smart 85 45°

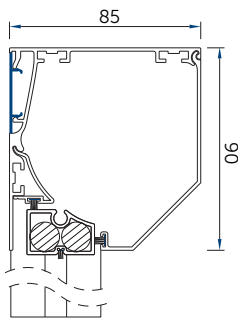

Smart 85 rekt.

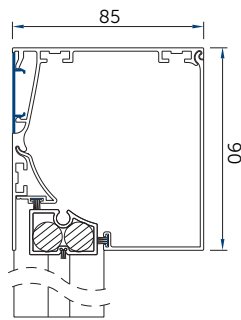

Endeprofil

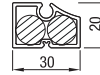

Styreskinner

STG-S

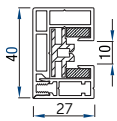

*Afstandsskinner og afstandsbeslag

MSTG

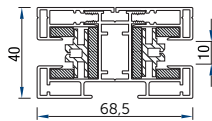

STG Click

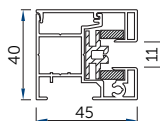

Maks.	bredde (cm)	højde (cm)	areal (m ²)
Smart 85	300	200	6,0

Smart 85 fås udelukkende med motor.

Smart 100

Smart 100 rekt.

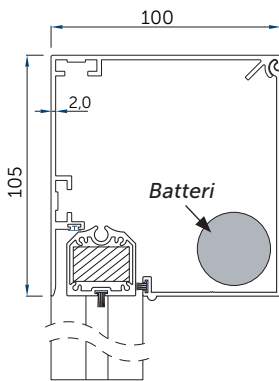

Med Smart 100 rekt. er det muligt at bruge den trådløse Somfy RTS motor med et batteri placeret inde i kassetten. Maks. dimensioner er 3,50 x 2,80 m.



Endeprofil

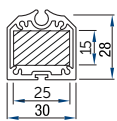

Styreskinner

MSTG

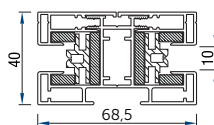

STG Click

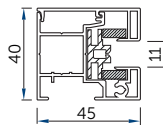

*Afstandsskinner og afstandsbeslag

Maks.	bredde (cm)	højde (cm)	areal (m ²)
Smart 100	400	300	12,0

Smart 100 fås udelukkende med motor.

*Afstandsskinner og afstandsbeslag til Smart 85, 100 og 130 – KUN til styreskinner: MSTG og STC Click

Afstandsskinner

Smart 85
Smart 100
Smart 130

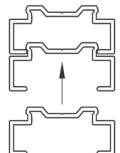
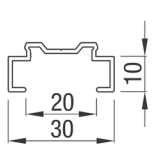

Max 5 stk
i kobling

Afstandsbeslag

Smart 85
Smart 100
Smart 130

7 eller 10 cm

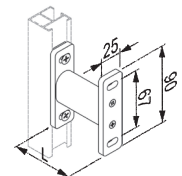

Smart 130

Smart 130 rekt.

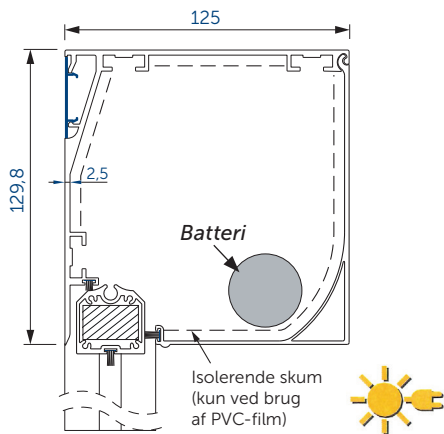

Smart 130 rekt.

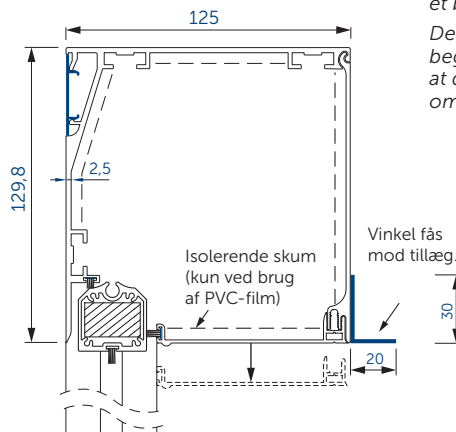

Med Smart 130 rekt. er det muligt at bruge den trådløse Somfy RTS motor med et batteri placeret inde i kassetten.

De maksimale dimensioner er herefter begrænset til 2,40 x 3,00 m, forudsat at de ikke overskrider det maksimale område for 10 Nm-motoren.

Endeprofil

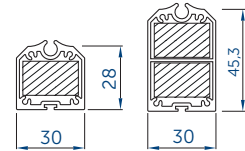

Styreskiner
MSTG

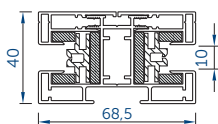

STG Click

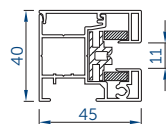

***Afstandsskiner og afstandsbeslag**

	Maks. rør (cm)	bredde (cm)	højde (cm)	areal (m ²)
Smart 130	Ø78	400	600	24,0
Smart 130	Ø85	540	500	27,0
Smart 130	Ø100	600	280	16,8

Smart 130 fås udelukkende med motor.

Smart 130 XL

Montering på pergola

Smart 130 XL kant

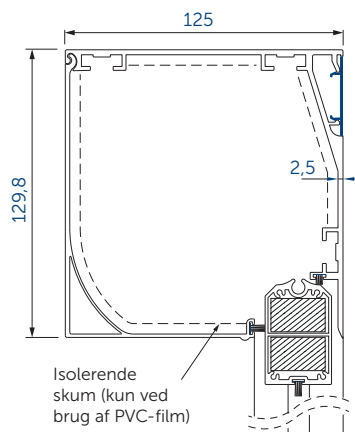

50 cm | 50 cm | 50 cm | 50 cm | 50 cm | 50 cm |

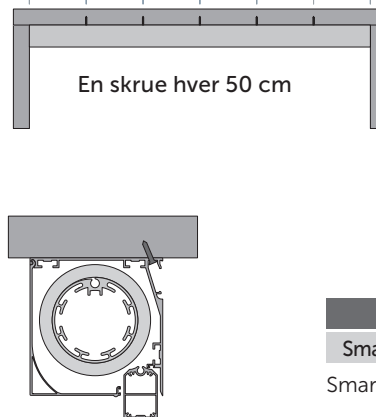

Endeprofil

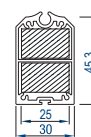

STG Click

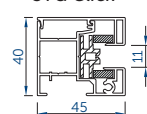

	Maks. bredde (cm)	Max højde (cm)
Smart 130 XL	600 - 700	280

Smart 130 fås udelukkende med motor.

SMART 100 STG-S

100 STG-S rekt.

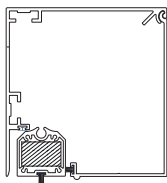

Endeprofil
Midi

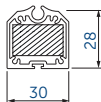

Styreskinne
STG-S

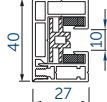

Maks.	bredde (cm)	højde (cm)	areal (m ²)
Smart 100 STG-S	400	300	12,0

Smart 100 STG-S fås udelukkende med motor.

SMART 130 STG-S

130 STG-S rekt.

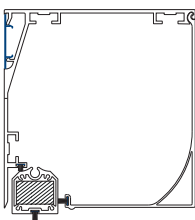

Endeprofil
Midi

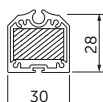

Styreskinne
STG-S

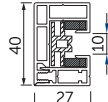

Maks.	bredde (cm)	højde (cm)	areal (m ²)
Smart 130 STG-S	450	450	20,2

Smart 130 STG-S fås udelukkende med motor.

Fås i op til 6 kassettefarver

Farve tættest på RAL*

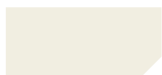

RAL 9010
White



RAL 7016
Anthracite gray

Struktur overflade*



STR 9S07
Gray aluminium

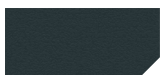

STR 7S16
Anthracite gray



tiger 29/80081
Iron Glimmer (Struktur)



RAL 9S05
Black

Betjening og duge – kan fås med Somfy- eller Faher Solar BI motor

somfy®

Markedsledende producent i både motorer og betjening. Alt til fremtidens hjem. 5 års garanti.

FAHER

Til det moderne hjem. En stabil motor, der fås med kabel eller fjernbetjening.

SCREENS DUGE – lækker vejrbestandig kvalitet. 65 dugfarver og 3 typer screenstoffer fra mørklægning over til transparent.

Der ydes ikke garanti på maling, korrosion eller rust opstået på produkter der er monteret i kystnære områder (radius af 10 km).